







MULTI

Design meets performance

 MULTI è un bordo sensibile dalla forma piacevole e dalle grandi performance. Utilizza un sistema a microinterruttori stagni ed è il prodotto ideale per i cancelli scorrevoli. Disponibile anche con trasmettitore wireless integrato e con giunto per connettere più bordi assieme.

 MULTI is a safety edge with a nice looking shape and great performances. It uses IP67 microswitches and it's the ideal product for sliding gates. MULTI is also available with integrated wireless transmitter. Many bars can be joined together using the optional junction.

 MULTI est un bord sensible de forme attrayante et aux grandes performances. Il utilise un système à micro interrupteurs étanches et est idéal pour les portails coulissants. Il est également disponible avec transmetteur sans fil intégré et avec un manchon pour connecter plusieurs bords sensibles ensemble.

 MULTI ist eine Kontaktleiste in gefälligem Design mit großartiger Leistung. Sie arbeitet mit einem System dichter Mikroschalter und eignet sich ideal für Schiebetore. Sie ist auch mit einem integrierten, zum Anschluss weiterer Kontaktleisten geeigneten Funksender erhältlich.

 MULTI es un borde sensible con una forma atractiva que ofrece grandes prestaciones. Utiliza un sistema de microinterruptores estancos y es el producto ideal para puertas correderas. También está disponible con transmisor inalámbrico integrado y con junta para conectar varios bordes juntos.



**TOTAL
SAFETY**

Safety guaranteed on all border's length, including endcaps.

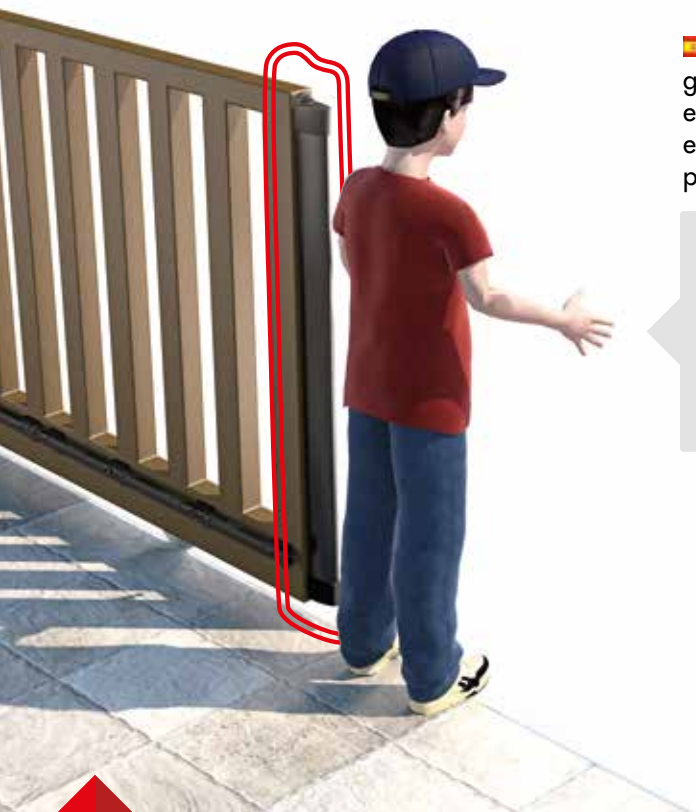

APPLICATIONS

SIZES

LENGTHS AND TRIMMING

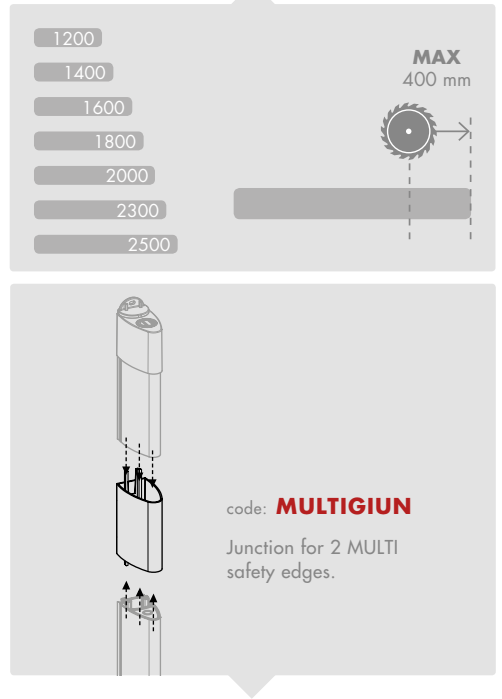
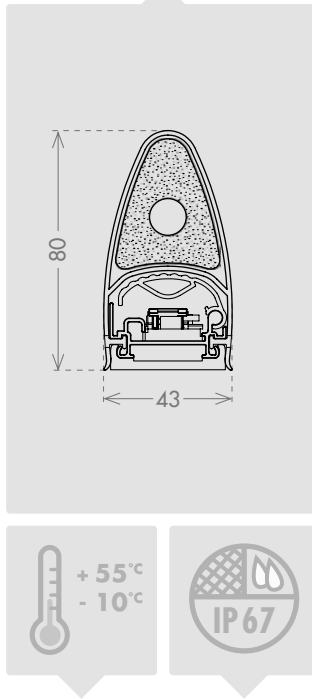
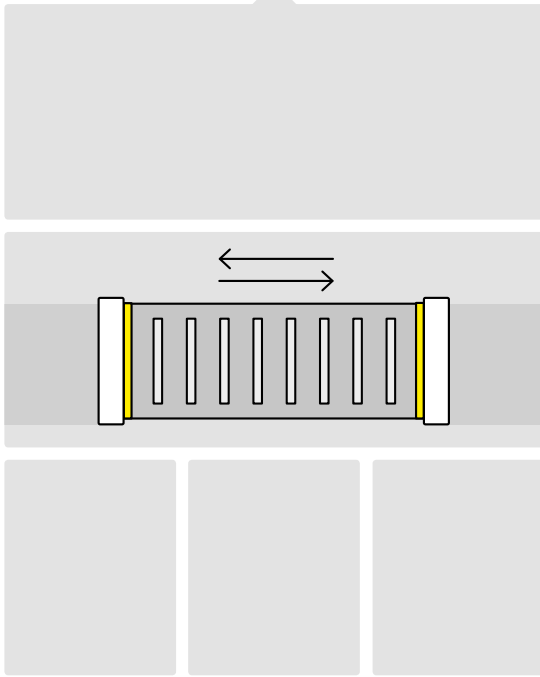

TEMPERATURE

MICROSWITCH
IP RATING

ACCESSORY

MULTI CONTROL

code: **MULTICT**

MULTI PROTO

code: **MULTIPR**

