

## SEGNALATORI OTTICO - ACUSTICI OPTICAL - ACOUSTIC SIGNALERS

### RLI 3-30V

Ripetore da incasso a luce fissa (LED rosso di serie) – alimentazione da 3 Vdc a 30 Vdc – consumo: 10 mA – Peso: 8 gr.

Steady-light repeater for flush installation (red LED standard) – power supply from 3 Vdc to 30 Vdc – consumption: 10 mA – Weight: 8 gr.

Disponibile anche in versione con LED colorati (bianco, verde, blu e giallo).

Also available with coloured LEDs (white, green, blue and yellow).

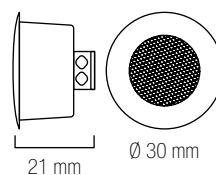

Supporto disponibile nei colori / Support is available in the following colours:



### RL 3V-12/24V

Ripetore a luce fissa – alimentazione 3 Vdc o 12/24 Vdc. Peso: 23 gr.

3 Vdc or 12/24 Vdc steady-light repeater. Weight: 23 gr.

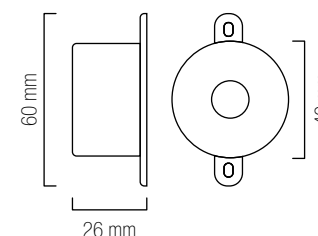
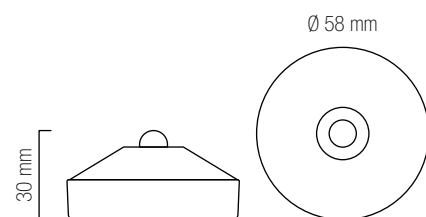

### BZ 96

Buzzer piezoelettrico – alimentazione 3-24 Vdc – assorbimento 13 mA – potenza sonora 96 dB (A) a 1 m. Peso: 20 gr.

Piezoelectric buzzer – power supply 3-24 Vdc – consumption 13 mA – sound power 96 dB (A) at 1 m. Weight: 20 gr.

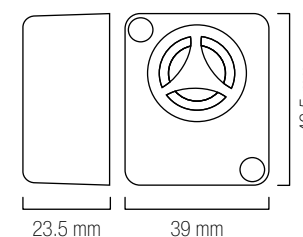

### BZ 100

Buzzer di potenza – alimentazione 6-15 Vdc – assorbimento 130 mA MAX – potenza sonora 108 dB (A) a 30 cm. Peso: 30 gr.

High-power buzzer – power supply 6-15 Vdc – consumption 130 mA MAX – sound power 108 dB (A) at 30 cm. Weight: 30 gr.

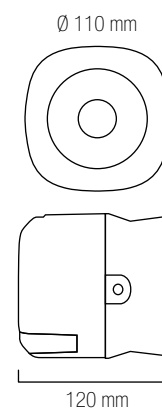

### TR 400

Tromba magnetodinamica di alta potenza ideale per ambienti industriali con forte rumore di fondo. Frequenza di suono modulata – protezione contro l'inversione di polarità – circuito elettronico tropicalizzato con resina ad immersione.

Alimentazione 12 V – assorbimento 800 mA – potenza sonora 118 dB (A) a 1 m – frequenza di suono 2400 Hz modulata – dotazione staffa di fissaggio. Peso: 1091 gr.

High power magneto-dynamic horn, suitable for very noisy industrial locations. Modulated sound frequency, protection against polarity inversion and electronic circuit tropicalized through resin immersion. Power supply 12 V – consumption 800 mA – sound power 118 dB (A) at 1 m – sound frequency 2400 Hz modulated – fixing clamp included. Weight: 1091 gr.



# ONDA LUX

Lampeggiante da parete a 12/24 Vdc a basso consumo configurabile a luce fissa o lampeggiante.

Versione combinata LED rosso/verde o bianco/blu – applicabile su scatola da incasso 503. Protezione IP 54. Peso: 213 gr.

Wall flashing light 12/24 Vdc, low consumption, light can be set in fixed and flashing mode.

Combined version with red/green or white/blue LEDs. Installable in 503 box. IP 54 protection. Weight: 213 gr.



# FL100 LED

Lampeggianti a LED con lampeggi regolabili da 50 a 100 al minuto – alimentazione 12/24 Vdc – base in ABS e lenti in VEDRIL – circuito elettronico protetto in resina e contro l'inversione di polarità. Grado di protezione IP 55. Peso: 260 gr.

LED flashing light with adjustable blinks from 50 to 100 per minute – power supply 12/24 Vdc – base in ABS and lens in VEDRIL – electronic circuit protected through resin immersion and against polarity inversion. Protection IP 55. Weight: 260 gr.

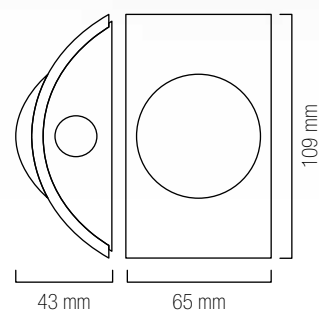

**Montaggio verticale e orizzontale**  
Vertical and horizontal mounting

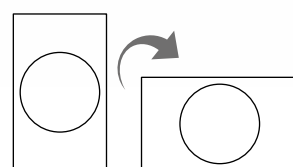

**Compatibile con BOX 503**  
BOX 503 compatible

